

# 2023 catalog

For CO<sub>2</sub> and fiber laser consumables

Replacement parts suitable for Prima Industrie<sup>®</sup>





## Centricut delivers

- OEM quality nozzles, ceramics and optics
- Technical and application support from our OEM-trained technicians
- 100% satisfaction guarantee

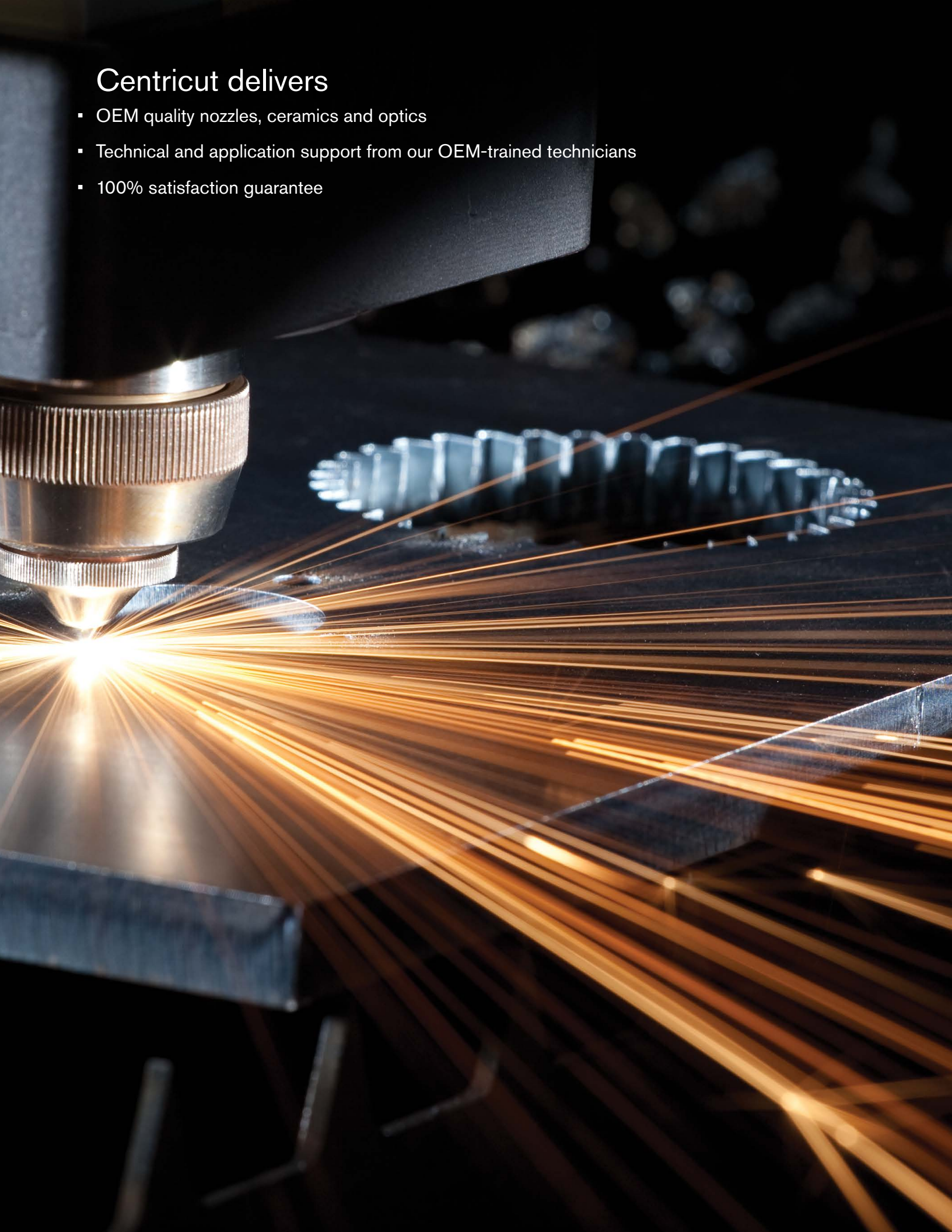

# CO<sub>2</sub> and fiber laser nozzles

## Nozzle options

All Centricut nozzles are engineered and manufactured to the highest standards. Select the OEM quality nozzle best suited for your application needs

### Copper

Most commonly used nozzle offering good durability and nozzle life. Primary nozzle type for fiber lasers.

### Chrome plated

Shiny, mirror-like finish provides increased spatter resistance, improved durability and longer life than copper nozzles. Not recommended for use on fiber lasers.

Look for CP in the part number to identify a chrome plated nozzle

### Hard chrome plated

Premium nozzles offering the highest level of durability and longest nozzle life. These nozzles are not as shiny as chrome plated and have a dull appearance. Not recommended for use on fiber lasers.

Look for HCP in the part number to identify a hard chrome nozzle.

CP (chrome plated)	Nozzles plated with chrome for increased durability. These nozzles are easier to clean, resist damage due to 'tip-ups' and have better spatter resistance over non-plated nozzles. For use in all laser cutting applications.
Conical	Conical internal geometry for high pressure, non-ferrous cutting applications using nitrogen, air or argon.
Cylindrical	Cylindrical internal geometry for low pressure, mild steel cutting applications using oxygen.
Double	Insert pressed into a standard cylindrical nozzle for improved edge quality, laminar gas flow and spatter resistance. Primarily used in mild steel applications.
HCP (hard chrome plated)	Enhanced durability chrome plated nozzles. These nozzles are easier to clean, resist damage due to 'tip-ups' and have better spatter resistance over non-plated nozzles. For use in all laser cutting applications.
HP (high pressure) HD (high density)	Conical style nozzle for high pressure, non-ferrous cutting applications using nitrogen, air or argon.
Inner	Also referred to as a 'nozzle insert'. Works in conjunction with an outer nozzle to create a double nozzle. Primarily used in mild steel applications.
Low pressure	Cylindrical style nozzle for low pressure, mild steel cutting applications using oxygen.
Outer	Works in conjunction with an inner nozzle to create a double nozzle. Primarily used in mild steel applications.
Shower	Nozzles with a center orifice surrounded by smaller jets. The smaller jets focus the assist gas into the kerf, creating improved edge quality and the ability to cut thicker material. Primarily used in mild steel applications.

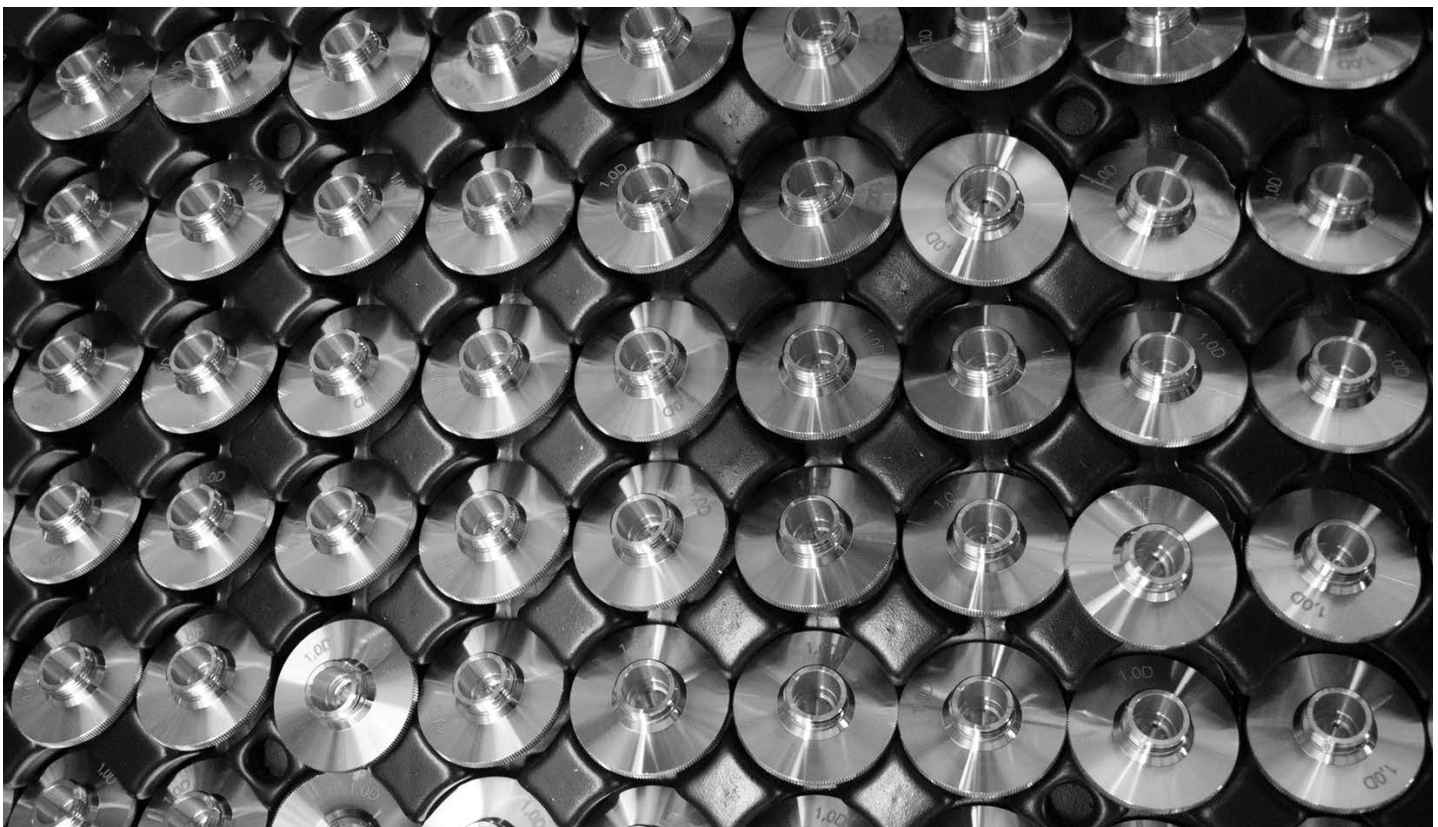



# CO<sub>2</sub> and fiber laser optics

## Optics key

Lens	
MEN	Meniscus
PLX	Plano-convex
MTD	Mounted
Not MTD	Not mounted
PO	Plano
MP5 or ULA	Ultra low absorption
AR	Anti-reflection
ZNSE	Zinc selenide
FS	Fused silica
DIA	Diameter
FL	Focal length
ET	Edge thickness
WD	Working distance

## How to handle optics

Follow these easy steps, when cleaning or changing your optic, to help maximize the life and performance of your lens

- Avoid touching coated surfaces of the lens and hold the optic by its sides
- Wear powder-free finger cots or latex gloves when handling
- Do not use any tools or sharp objects when handling the optic or when removing it from its packaging
- Ensure the work surface is clean and free of oils, grease and dirt
- Do not place the optic on hard surfaces as they scratch easily
- Once the optic has been unpacked, carefully place it on the lens tissue in which it was originally wrapped

## Optics disposal

It is important to dispose of used laser optics at a licensed industrial waste facility which is in compliance with all local, state, and federal regulations. If you don't have access to a licensed industrial waste facility, and purchased your laser optics through Centricut, you may return them to Centricut for proper disposal. This service is only available to Centricut customers.

### All optics returned to Centricut must:

- Include return authorization and invoice numbers
- Be sealed in a plastic bag to minimize any hazards
- Remove excess ZnSe powder prior to sealing

\*Acceptance of goods will be refused if not packaged correctly or if the return authorization number isn't included



# Optics

Centricut part number	Reference number	Type	Material	Diameter	Focal length	Edge thickness
Fiber laser lens						
NT375-7955		PLX	FS	30 mm	123 mm	3.82 mm
TR300-9799	1869799	PLX	FS	30 mm	146 mm	8.0 mm
TR300-3107	1603107	PLX	FS	40 mm	150 mm	8.0 mm
AM313-0238	7710238, 71565737	PLX	FS	50.8 mm	190 mm	11.4 mm
SA384-0022	316-301-0022, 970128	PLX	FS	25.4 mm	200 mm	6.35 mm
SA384-0026	316-301-0026, ESTFLO2119	PLX	FS	38.1 mm	210 mm	6.35 mm
PR361-8988NM	968988, 344631	PLX	FS	1.5"	5.0"	.280"
MB312-8858		PLX	FS	2.0"	7.5"	.45"
PR361-0773	970773/M15-15-B X-SP-7MM	PLX MTD	FS	1.5"	5.0"	.275"
PR361-8988	LH968988PVL, 576.41.005	PLX MTD	FS	1.5"	5.0"	.280"

Centricut part number	Reference number	Material	Diameter	Edge thickness
Fiber laser windows				
PT317-1424	P0588-1022-00001	FS	21.5 mm	2.0 mm
PT317-0589	970397, 6930003260, P0589-360-00002, R26RT006410, R26ZC90110	FS	22.35 mm	4.0 mm
PT317-9360	6930003260, P0589-360-00001	FS	22.35 mm	4.0 mm
MB312-2336	632336-117	FS	25.4 mm	4.0 mm
RT300-0035 <b>NEW</b>	211LCG0035, 211LCG0037	FS	27.9 mm	4.1 mm
PT317-0010	P0253-1034-00001	FS	30.0 mm	1.5 mm
TR300-6719	766719, P0795-1201-00002	FS	30.0 mm	5.0 mm
SA384-0007	316-304-0007, ESTFLO01407, 632755-117	FS	32.0 mm	6.35 mm
BY314-5979 <b>NEW</b>	10086368, 10071591, 5335979	Sapphire	34.0 mm	2.8 mm
TR300-4767	1614767	FS	34.0 mm	4.9 mm
PR361-0089	1057.81000.089	FS	35.0 mm	1.5 mm
BY314-5746	968752, 10045746, 10-02-01-5511	QTZ	36.0 mm	5.0 mm
PR361-0474	970474	FS	37.0 mm	4.0 mm
PT317-1551	P0595-61551, P0595-58601-61551	FS	37.0 mm	7.0 mm
PT317-1425	SCR-01	FS	38.0 mm	5.2 mm
CN307-3987	913987, 71598028	FS	38.1 mm	1.6 mm
MZ315-6850 <b>NEW</b>	Z50ZZ016850	FS	42.0 mm	9.0 mm
MZ315-5350	Z50SA015350, W495	FS	42.0 mm	9.0 mm
AM313-1308	71571308, 5172635	FS	45.0 mm	3.0 mm
PT317-5919	77005919	FS	48.0 mm	7.0 mm
PT317-1789	284.0402, 971789, 717062	FS	50.0 mm	3.18 mm
MB312-0137	633744-137	FS	50.0 mm	8.0 mm
AM313-0026	71570026	FS	OCTAGONAL	1.5 mm

Centricut is not affiliated with the named manufacturers. Reference to machines, parts, descriptions, and model numbers are for convenience in verifying compatibility only. All parts are made by or for Centricut and are not made by the referenced manufacturers (unless expressly indicated). Centricut is a registered trademark of Hypertherm, Inc. All other trademarks are the properties of their respective owners.

Centricut part number	Reference number	Type	Material	Diameter	Focal length	Edge thickness
CO <sub>2</sub> lenses						
TR300-0115 <b>NEW</b> (Cut - No RFID)		MEN	ZNSE	1.969"	4.528"	.350"
TR300-0130 <b>NEW</b> (Cut - No RFID)	400130LMA , 0380117, D40 Cut, 630790-117	MEN	ZNSE	1.575"	5.118"	.295"
TR300-8123 <b>NEW</b>	518123	MEN	ZNSE	1.575"	6.102"	.295"
TR300-0175 <b>NEW</b> (Cut - No RFID)	1330448, 62440	MEN	ZNSE	1.969"	6.89"	.350"
TR300-0250 <b>NEW</b> (Cut - No RFID)	400250LMA, 0380115, D40 Cut, 630789-117	MEN	ZNSE	1.575"	9.842"	.295"
TR300-2500 <b>NEW</b> (Cut - No RFID)	1330443, 62439	MEN	ZNSE	1.969"	9.842"	.350"
LL342-1819	166634, 61819	MEN	ZNSE	1.1"	5.0"	.236"
TR300-0163	350163, 861143, LMZ1.5-0.29-10.00-2048	MEN	ZNSE	1.5"	10.0"	.290"
TR300-6477	726477	MEN	ZNSE	1.5"	10.0"	.354"
BY314-0185	4-00185, 4-00372, 142375, 60603	MEN	ZNSE	1.5"	3.75"	.236"
TR300-6104	346104, 61962, 831393	MEN	ZNSE	1.5"	3.75"	.290"
BY314-0736	414323, 4-10736	MEN	ZNSE	1.5"	3.75"	.354"
BY314-0186	60260, 507790, 4-00186, 110111	MEN	ZNSE	1.5"	5.0"	.236"
TR300-8114	088114, 60696, 406294, 110109, 61014, 658108, 29100023, 6930001002	MEN	ZNSE	1.5"	5.0"	.290"
BY314-5094	767963, 60615, 4-05094, 110113, 358186, 62710	MEN	ZNSE	1.5"	5.0"	.354"
PR361-0004	62709, 621644, 120216	MEN	ZNSE	1.5"	5.0"	.354"
PT317-0001	61851, 312370	MEN	ZNSE	1.5"	7.5"	.125"
BY314-0187	784964, 60602, 4-00187, 110112	MEN	ZNSE	1.5"	7.5"	.236"
TR300-7517	097517, 60697, 702232, 110110, 61983	MEN	ZNSE	1.5"	7.5"	.290"
LL342-1171	61171	MEN	ZNSE	1.5"	7.5"	.310"
BY314-5095	60616, 4-05095, 570721, 110114, 361129	MEN	ZNSE	1.5"	7.5"	.354"
BY314-8637	698637	MEN	ZNSE	1.5"	7.5"	.354"
TR300-1972	61961, 141972, 977976	MEN	ZNSE	1.5"	8.85"	.290"
TR300-8123	518123	MEN	ZNSE	1.575"	6.102"	.295"
LV333-0176	480176, 29100115	MEN	ZNSE	1.75"	5.0"	.354"
LV333-1551	981551, LMZ2.0-0.380-10.0-2053, 29100061S	MEN	ZNSE	2.0"	10.0"	.380"
PT317-6326	206326	MEN	ZNSE	2.0"	5.0"	.378"
LV333-1004	458138, LMZ2.0-0.380-5.00-2051, PLLMZ0024, 29100154	MEN	ZNSE	2.0"	5.0"	.380"
CN307-2376	61405, 695399, 922376, 60698, 29100055	MEN	ZNSE	2.0"	7.5"	.380"
AM313-0305	61161, 81140305, LPCZ-1.10-0.16-5.0-1044, PLLPZ0132, 561067	PLX	ZNSE	1.1"	5.0"	.160"
AM313-6602	726602	PLX	ZNSE	1.1"	7.5"	.160"
AM313-0657	600657, 71502030, LPCZ-1.5-0.30-10.0-1128	PLX	ZNSE	1.5"	10.0"	.300"
TK374-2235	312235	PLX	ZNSE	1.5"	12.5"	.300"
PT317-8950	148950	PLX	ZNSE	1.5"	2.5"	.085"
MZ315-0130	60830, Z50MB000130, 962834, 766479	PLX	ZNSE	1.5"	5.0"	.118"
TR300-0002	61163, LMZ1.5-0.16-5.00-2043, 706491, 907557, PLCZ-1.5-0.16-5.0-1116	PLX	ZNSE	1.5"	5.0"	.160"
MZ315-0160	60770, 227092, Z50MB000130H, LPCZ-1.5-0.236-5.0-1122, 834-319-002	PLX	ZNSE	1.5"	5.0"	.236"
PR361-9011	834-319-011, 60905, 658108, ZC15500300, Z50MB000400, 578662, MLL00016	PLX	ZNSE	1.5"	5.0"	.300"
MB312-500	W500, 60905, 110144, LPCZ-1.5-0.30-5.0-1125, PLLPZ0132	PLX	ZNSE	1.5"	5.0"	.310"
CN307-8085	941031, 61001, 908085, ZC15513280, 110092, PLLPZ0033	PLX	ZNSE	1.5"	5.0"WD	.280"
PR361-0003	60784, LPCZ-1.5-0.236-7.5-1123	PLX	ZNSE	1.5"	7.5"	.236"
PR361-9012	834-319-012, 60906, 618938, 306068, 741363, 60882, 299133, 71501070NM, 62649	PLX	ZNSE	1.5"	7.5"	.300"
MB312-018	60906, W018, 383862, 60906LA, W018, 62649ULA, 383862, 62649LA	PLX	ZNSE	1.5"	7.5"	.310"
CN307-9484	909484, 61002, 464497, 100096, LPCZ-1.5-0.280-5.13-1007, PLLPZ0052	PLX	ZNSE	1.5"	7.5"WD	.280"
PT317-8275	628275, W502A, 630736-117	PLX	ZNSE	2.0"	10.0"	.310"
PT317-0537	960537	PLX	ZNSE	2.0"	10.0"	.380"
CN307-4498	154498, 926274	PLX	ZNSE	2.0"	10.0"WD	.380"
TK374-7338	197338	PLX	ZNSE	2.0"	11.25"	.310"
MZ315-5980	145980	PLX	ZNSE	2.0"	5.0"	.300"
MB312-505	W505, 110169, PLLPZ0162, 304725, 61003, Z50ZZ005160	PLX	ZNSE	2.0"	5.0"	.310"
MZ315-0516A	61019, Z50ZZ00516A, Z50ZZ013480, 81140307, 741363	PLX	ZNSE	2.0"	5.0"	.380"

Centricut is not affiliated with the named manufacturers. Reference to machines, parts, descriptions, and model numbers are for convenience in verifying compatibility only. All parts are made by or for Centricut and are not made by the referenced manufacturers (unless expressly indicated). Centricut is a registered trademark of Hypertherm, Inc. All other trademarks are the properties of their respective owners.

Centricut part number	Reference number	Type	Material	Diameter	Focal length	Edge thickness
CO <sub>2</sub> lenses (continued)						
MZ315-3480HA	158039, Z50ZZ013480 HIGH ACCURACY	PLX	ZNSE	2.0"	5.0"	.380"
CN307-0676	870676, 61514, LPCZ-2.0-0.38-5.19-1141, PLLPZ0116	PLX	ZNSE	2.0"	5.0"WD	.380"
MZ315-3470HA	769062, Z50ZZ013470 HIGH ACCURACY	PLX	ZNSE	2.0"	7.5"	.380"
NT375-4494	634494, LPCZ-2.0-0.30-7.5-1133	PLX	ZNSE	2.0"	7.5"	.300"
MB312-510	W510, 61004, 892020, 110122, PLLPZ0138	PLX	ZNSE	2.0"	7.5"	.310"
MZ315-0520A	61405, 232771, Z50ZZ00520A, MLL00018, Z50ZZ005200, Z50ZZ013470, 81140186	PLX	ZNSE	2.0"	7.5"	.380"
CN307-1603	61515, 781603, LPCZ-2.0-0.38-7.67-1143, PLLPZ0115	PLX	ZNSE	2.0"	7.5" WD	.380"
TK374-3478	541344, 263478, Z50ZZ00530A, LPCZ-2.0-0.31-7.45-1137	PLX	ZNSE	2.0"	8.75"	.310"
TK374-6670	236670, 61690, Z50ZZ00550A	PLX	ZNSE	2.5"	10.0"	.390"
TK374-1592	178937	PLX	ZNSE	2.5"	11.25"	.310"
TK374-8593	828593	PLX	ZNSE	2.5"	12.5"	.390"
TK374-3827	243827, Z50ZZ00540A, LPCZ-2.5-0.31-8.75-1145	PLX	ZNSE	2.5"	8.75"	.310"
AM313-0221	81140221, 6067639	PLX MTD	ZNSE	1.5"	3.75"	.300"
AM313-0306	81140306, 65024, 578662/M16-15-1C-P5.0, PLLPZ0133, 6874793	PLX MTD	ZNSE	1.5"	5.0"	.300"
AM313-1216	578662/M20-15-1C-P5.0, 9001216A, 71501072, 7973109, 6360374	PLX MTD	ZNSE	1.5"	5.0"	.300"
AM313-8662	578662/M21-15-1C-P5.0, 6060415	PLX MTD	ZNSE	1.5"	5.0"	.300"
AM313-9830	65101, 578662, 6547252	PLX MTD	ZNSE	1.5"	5.0"	.300"
AM313-1215	9001215A, 306068/M21-15-1C-P7.5, 7973110, 71501070, 6395647	PLX MTD	ZNSE	1.5"	7.5"	.300"
AM313-9831	71369831, 65102, 6550214	PLX MTD	ZNSE	1.5"	7.5"	.300"
AM313-10F1	680154-001, 71710061, 6021844	PLX MTD	ZNSE	2.0"	10.0"	.380"
AM313-0307	65035, 81140307, 741363, 6068456	PLX MTD	ZNSE	2.0"	5.0"	.380"
AM313-50F1	71710059, 741363M30-20-1C-P5.0, 6296946	PLX MTD	ZNSE	2.0"	5.0"	.380"
AM313-0400	306068, 65025, 81140400, 6022704	PLX MTD	ZNSE	2.0"	7.5"	.300"
AM313-0186	65038, 81140186, PLLPZ0156, 6068413	PLX MTD	ZNSE	2.0"	7.5"	.380"
AM313-75F1	232771M31-20-1C-P7.5, 71710030, 6243925	PLX MTD	ZNSE	2.0"	7.5"	.380"
BY314-7014MP5	460386, 4-07014	MEN	ZNSE MP5	1.5"	10.0"	.354"
BY314-0186MP5	4-00186, 528717, 60260LA	MEN	ZNSE MP5	1.5"	5.0"	.236"
TR300-8114MP5	60696LA, 312503, 29100023, 88114, PLLPZ0125B	MEN	ZNSE MP5	1.5"	5.0"	.290"
BY314-5094MP5	123397, 4-07475, 60615LA, LMZ1.5-0.354-5.0-2008	MEN	ZNSE MP5	1.5"	5.0"	.354"
BY314-0187MP5	714512, 60602LA, 4-00187	MEN	ZNSE MP5	1.5"	7.5"	.236"
TR300-7517MP5	60697LA, 97517, 474644, PLLPZ0126B	MEN	ZNSE MP5	1.5"	7.5"	.290"
BY314-5095MP5	602033, 60616LA, 4-07476, LMZ1.5-0.354-7.5-2009, PLLPZ0130B, 62710	MEN	ZNSE MP5	1.5"	7.5"	.354"
BY314-8294MP5	996707, 10048294	MEN	ZNSE MP5	1.5"	9.0"	.354"
HW405-4913	114913	MEN	ZNSE MP5	2.0"	10.0"	.379"
HW405-5270	355270	MEN	ZNSE MP5	2.0"	5.0"	.378"
HW405-7143	527143, 467572, 60698LA, 291005-5, 308332, PLLMZ0025B	MEN	ZNSE MP5	2.0"	7.5"	.379"
MZ315-0160MP5	60770LA, 857048, Z50MB000160	PLX	ZNSE MP5	1.5"	5.0"	.236"
MZ315-0400MP5	106106, PLLPZ0132B, 60905LA, Z50MB000400, 62670ULA	PLX	ZNSE MP5	1.5"	5.0"	.300"
CN307-8085MP5	61001LA, 794914, 908085,	PLX	ZNSE MP5	1.5"	5.0"WD	.280"
MB312-018MP5	383862	PLX	ZNSE MP5	1.5"	7.5"	.300"
CN307-9484MP5	PLLPZ0052B	PLX	ZNSE MP5	1.5"	7.5"WD	.315"
MB312-505MP5	61003LA, 922203, W505	PLX	ZNSE MP5	2.0"	5.0"	.310"
AM313-0307NMP5	81140307, 61019LA, 753010	PLX	ZNSE MP5	2.0"	5.0"	.380"
CN307-0211MP5	540211, 61019LA, 922377	PLX	ZNSE MP5	2.0"	5.0"WD	.380"
MB312-510MP5	61004LA, 635061, W510,	PLX	ZNSE MP5	2.0"	7.5"	.310"
CN307-2376MP5	329011, 922376, 61515ULA,	PLX	ZNSE MP5	2.0"	7.5"	.380"
MZ315-0520AMP5	392125, 61405LA, Z50ZZ000520A, PLLPZ0135B, 81140186 61405ULA	PLX	ZNSE MP5	2.0"	7.5"	.380"

Centricut is not affiliated with the named manufacturers. Reference to machines, parts, descriptions, and model numbers are for convenience in verifying compatibility only. All parts are made by or for Centricut and are not made by the referenced manufacturers (unless expressly indicated). Centricut is a registered trademark of Hypertherm, Inc. All other trademarks are the properties of their respective owners.

Centricut part number	Reference number	Type	Material	Diameter	Focal length	Edge thickness
CO <sub>2</sub> lenses (continued)						
AM313-0306MP5	65024LA, 81140306, 106106, M16-15-1C-P5.0, 6936448	PLX MTD	ZNSE MP5	1.5"	5.0"	.300"
AM313-1216MP5	106106, M20-15-1C-P5.0, 6071896	PLX MTD	ZNSE MP5	1.5"	5.0"	.300"
AM313-9830MP5	71369830, 106106, 65101LA, 106106/M16-15-1C-P5.0-A2-NI-1A	PLX MTD	ZNSE MP5	1.5"	5.0"	.300"
AM313-0400MP5	65025LA, 383862/M16-15-1C-P7.5-A2-NI-1A, 81140400, 383862	PLX MTD	ZNSE MP5	1.5"	7.5"	.300"
AM313-1215MP5	M21-15-1C-P7.5, 383862, 6071853	PLX MTD	ZNSE MP5	1.5"	7.5"	.300"
AM313-9831MP5	65102LA, 71369831, 383862	PLX MTD	ZNSE MP5	1.5"	7.5"	.300"
AM313-0307MP5	81140307, M16-20-1C-P5.0, 753010, 65035LA, 753010M16-20-1C-P5.0	PLX MTD	ZNSE MP5	2.0"	5.0"	.380"
AM313-0186MP5	392125, 65038LA, M16-20-1C-P7.5, 81140186, 6816292	PLX MTD	ZNSE MP5	2.0"	7.5"	.380"

## Accessories

Centricut part number	Reference number	Description	Pkg qty
TR300-6452		Lens cleaning Tiffen paper (50 pcs)	1
TR300-1115		Lens cleaning pre-cut cotton (100 pcs)	1
TR300-1010		Dropper, lens cleaning fluid	1
TR300-1112		Optical cleaning fluid	1
TR300-0699	70675699 REVA	Lens cleaning swabs (25 pcs)	1
TR300-7991	27991	Polyester wipes 4" x 4" (100 pcs)	1
TR301-0282		Injector	1
TR300-LSA		Lens stress analyzer	1
TR300-255		Magnifying loop	1
TR300-271		Base, mirror maintenance	1
TR300-7388	787388	Mirror polish .1UM 250ML	1
MZ335-115	AL1115/M	MZ-Wire, Indium .8 mm x 125 mm 1.5" Lens	1
MZ335-120	AL1120/M	MZ-Wire, Indium .8 mm x 160 mm 2.0" Lens	1

Centricut is not affiliated with the named manufacturers. Reference to machines, parts, descriptions, and model numbers are for convenience in verifying compatibility only. All parts are made by or for Centricut and are not made by the referenced manufacturers (unless expressly indicated). Centricut is a registered trademark of Hypertherm, Inc. All other trademarks are the properties of their respective owners.



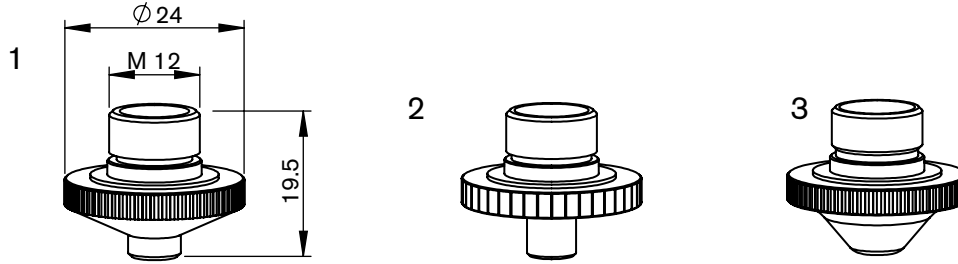

**Consumables**

	Centricut part number	Esse A part number	Reference number	Description	Pkg qty
1	PR351-1E110	L312		PR-Nozzle, 1.0 mm	1
	PR351-1E108	L362		PR-Nozzle, 1.2 mm	1
	PR351-1E111	L207	LW6.1E.111	PR-Nozzle, 1.5 mm	1
	PR351-1E112	L208	LW6.1E.112	PR-Nozzle, 2.0 mm	1
	PR351-1E113	L209	LW6.1E.113	PR-Nozzle, 2.5 mm	1
	PR351-1E114	L210	LW6.1E.114	PR-Nozzle, 3.0 mm	1
	PR351-1E111CP	L207X	LW6.1E.111	PR-Nozzle, 1.5 mm CP	1
	PR351-1E112CP	L208X	LW6.1E.112	PR-Nozzle, 2.0 mm CP	1
	PR351-1E113CP	L209X	LW6.1E.113	PR-Nozzle, 2.5 mm CP	1
	PR351-1E114CP	L210X	LW6.1E.114	PR-Nozzle, 3.0 mm CP	1
2	PR366-1G600	L608	LW6.1G.500, LW6.1G.600	PR-Nozzle, 1.5 mm	1
	PR366-1G601	L609	LW6.1G.501, LW6.1G.601	PR-Nozzle, 2.0 mm	1
	PR366-1G602	L610	LW6.1G.502, LW6.1G.602	PR-Nozzle, 2.5 mm	1
	PR366-1G603	L611	LW6.1G.503, LW6.1G.603	PR-Nozzle, 3.0 mm	1
	PR366-1G601CP	L609X	LW6.1G.501, LW6.1G.601	PR-Nozzle, 2.0 mm CP	1
	PR366-1G602CP	L610X	LW6.1G.502, LW6.1G.602	PR-Nozzle, 2.5 mm CP	1
3	PR362-0008CP	L905X		PR-Nozzle double, 0.8 mm CP	1
	PR362-0003CP	L900X	1059.70000.003	PR-Nozzle double, 1.0 mm CP	1
	PR362-0002CP	L907X	1059.70000.008	PR-Nozzle double, 1.25 mm CP	1
	PR362-0005CP	L901X	1059.70000.004	PR-Nozzle double, 1.5 mm CP	1
	PR362-0001CP	L906X	1059.70000.009	PR-Nozzle double, 1.75 mm CP	1
	PR362-0004CP	L902X	1059.70000.005	PR-Nozzle double, 2.0 mm CP	1
	PR362-0006CP	L903X	1059.70000.006	PR-Nozzle double, 2.5 mm CP	1
	PR362-0007CP	L904X	1059.70000.007	PR-Nozzle double, 3.0 mm CP	1

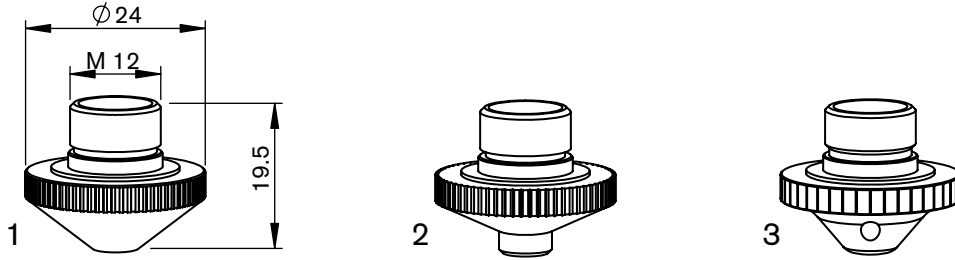

**Consumables**

	Centricut part number	Esse A part number	Reference number	Description	Pkg qty
1	PR422-0002	L863		PR-Nozzle, 1.5 mm	1
	PR422-0003	L864		PR-Nozzle, 2.0 mm	1
2	PR422-0650CP	L1165X	LW6.1G.650	PR-Nozzle, 3.0 CP	1
3	PR394-604	L1167X	LW6. 1G. 604	PR-Nozzle, 1.5 mm CP	1
	PR394-603	L1166X	LW6.1G.603	PR-Nozzle, 1.75 mm CP	1
	PR394-605	L1168X	LW6. 1G. 605	PR-Nozzle, 2.0 mm CP	1
	PR394-606	L1169X	LW6. 1G. 606	PR-Nozzle, 2.5 mm CP	1
	PR394-607	L1170X	LW6. 1G. 607	PR-Nozzle, 3.0 mm CP	1

**Consumables**

	Centricut part number	Esse A part number	Alternate reference	Description	Pkg qty
	PR361-3150 (not shown)	AL628	99MM-150MM	PR-Sensor cable, 150 mm (6")	1

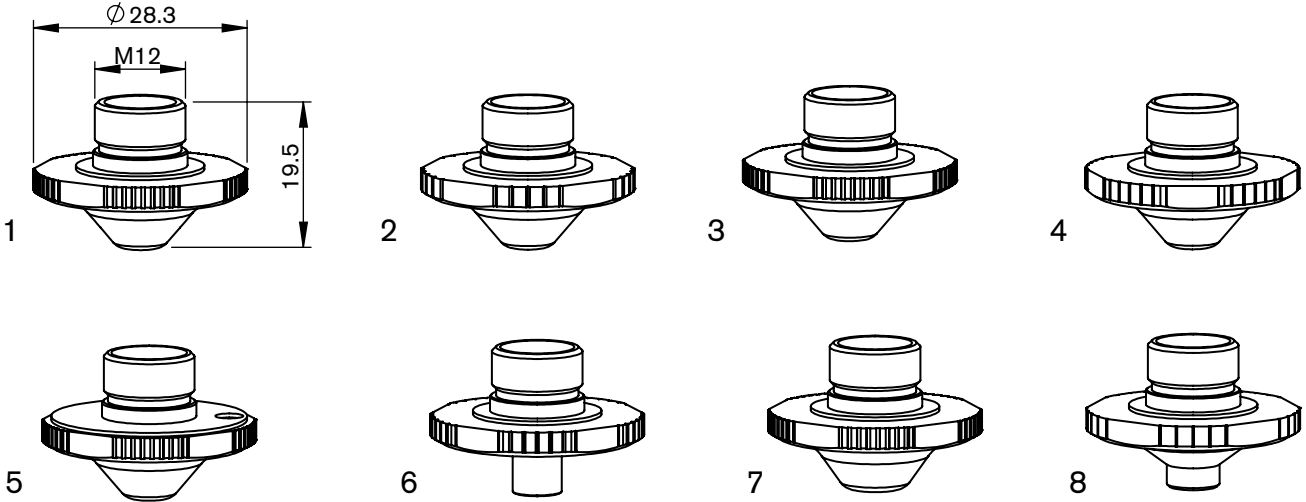

**Consumables**

	Centricut part number	Esse A part number	Reference number	Description	Pkg qty
1	PR422-0663	L1431X	LW6.1G.663	PR-Nozzle pentagonal, 1.5 mm CP	1
	PR422-0664	L1432X	LW6.1G.664	PR-Nozzle pentagonal, 1.75 mm CP	1
	PR422-0665	L1433X	LW6.1G.665	PR-Nozzle pentagonal, 2.0 mm CP	1
	PR422-0667	L1435X	LW6.1G.667	PR-Nozzle pentagonal, 2.5 mm CP	1
	PR422-0669	L1437X	LW6.1G.669	PR-Nozzle pentagonal, 3.0 mm CP	1
2	PR422-0101CP	L1805X		PR-Nozzle pentagonal, 1.0 mm CP	1
	PR422-0103CP	L1807X	LW6.1G.103	PR-Nozzle pentagonal, 1.5 mm CP	1
	PR422-0105CP	L1808X	LW6.1G.105	PR-Nozzle pentagonal, 2.0 mm CP	1
	PR422-0107CP	L1809X	LW6.1G.107	PR-Nozzle pentagonal, 2.5 mm CP	1
	PR422-0109CP	L1810X	LW6.1G.109	PR-Nozzle pentagonal, 3.0 mm CP	1
3	PR422-1462	L1462	LW6.1G.200	PR-Nozzle double pentagonal, 3.0 mm	1
	PR422-1463	L1463	LW6.1G.201	PR-Nozzle double pentagonal, 3.5 mm	1
	PR422-1464	L1464	LW6.1G.202	PR-Nozzle double pentagonal, 4.0 mm	1
	PR422-1472	L1472	LW6.1G.203	PR-Nozzle double pentagonal, 5.0 mm	1
	PR422-1473	L1473	LW6.1G.204	PR-Nozzle double pentagonal, 7.0 mm	1
	PR422-2200	L2200	LW6.1G.311	PR-Nozzle double pentagonal SMT 3.0 mm	1
	PR422-2203	L2203	LW6.1G.312	PR-Nozzle double pentagonal SMT 4.0 mm	1
	PR422-1783CP	L1783X	LW6.1G.302	PR-Nozzle double pentagonal, 1.25 mm CP	1
	PR422-1784CP	L1784X	LW6.1G.303	PR-Nozzle double pentagonal, 1.5 mm CP	1
	PR422-1785CP	L1785X	LW6.1G.304	PR-Nozzle double pentagonal, 1.75 mm CP	1
	PR422-1786CP	L1786X	LW6.1G.305	PR-Nozzle double pentagonal, 2.0 mm CP	1
	PR422-1787CP	L1787X	LW6.1G.307	PR-Nozzle double pentagonal, 2.5 mm CP	1
	PR422-2197CP	L2197X	LW6.1G.310	PR-Nozzle double pentagonal D 2.5 MM CP	1
	PR422-1789CP	L1789X	LW6.1G.309	PR-Nozzle double pentagonal, 3.0 mm CP	1
	PR422-1791CP	L1791X	LW6.1E.207	PR-Nozzle double pentagonal, 3.5 mm/inner 3.0 mm CP	1

(Continued on next page)



**Consumables**

	Centricut part number	Esse A part number	Reference number	Description	Pkg qty
4	PR422-0682	L1442X	LW6.1G.682	PR-Nozzle double pentagonal, 1.25 mm CP	1
	PR422-0683	L1443X	LW6.1G.683	PR-Nozzle double pentagonal, 1.5 mm CP	1
	PR422-0684	L1444X	LW6.1G.684	PR-Nozzle double pentagonal, 1.75 mm CP	1
	PR422-0685	L1445X	LW6.1G.685	PR-Nozzle double pentagonal, 2.0 mm CP	1
	PR422-0687	L1447X	LW6.1G.687	PR-Nozzle double pentagonal, 2.5 mm CP	1
	PR422-0689	L1449X	LW6.1G.689	PR-Nozzle double pentagonal, 3.0 mm CP	1
	PR422-0801	L1466	LW6.1G.801	PR-Nozzle double brilliant, 3.5 mm	1
	PR422-0803	L1468	LW6.1G.803	PR-Nozzle double brilliant, 5.0 mm	1
5	PR422-0627	L1453X	LW6.1G.627	PR-Nozzle triple pentagonal, 1.25 mm CP	1
	PR422-0620	L1454X	LW6.1G.620	PR-Nozzle triple pentagonal, 1.5 mm CP	1
	PR422-0621	L1455X	LW6.1G.621	PR-Nozzle triple pentagonal, 1.75 mm CP	1
	PR422-0622	L1456X	LW6.1G.622	PR-Nozzle triple pentagonal, 2.0 mm CP	1
	PR422-0624	L1458X	LW6.1G.624	PR-Nozzle triple pentagonal, 2.5 mm CP	1
	PR422-0626	L1460X	LW6.1G.626	PR-Nozzle triple pentagonal, 3.0 mm CP	1
6	PR422-0700	L1478X	LW6.1G.700	PR-Nozzle pentagonal cyl, 2.0 mm CP	1
	PR422-0701	L1479X	LW6.1G.701	PR-Nozzle pentagonal cyl, 2.5 mm CP	1
	PR422-0702	L1480X	LW6.1G.702	PR-Nozzle pentagonal cyl, 3.0 mm CP	1
7	PR422-0522CP	L1837X	LW6.1G.522a	PR-Nozzle pentagonal DL, 3.0 mm inner/ 4.5 mm CP	1
8	PR422-0524CP	L1838X	LW6.1G.524	PR-Nozzle pentagonal, 3.0 mm DL CP	1

Centricut is not affiliated with the named manufacturers. Reference to machines, parts, descriptions, and model numbers are for convenience in verifying compatibility only. All parts are made by or for Centricut and are not made by the referenced manufacturers (unless expressly indicated). Centricut is a registered trademark of Hypertherm, Inc. All other trademarks are the properties of their respective owners.

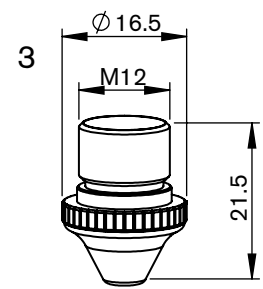
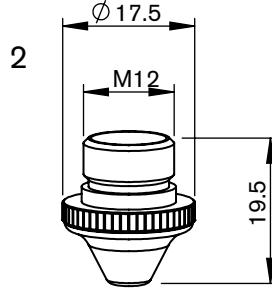
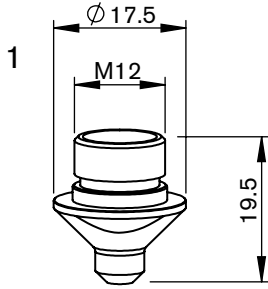

**Consumables**

	Centricut part number	Esse A part number	Reference number	Description	Pkg qty
1	PR398-550	L892	750.42.550	PR-Nozzle, 1.5 mm	1
	PR398-551	L893	750.42.551	PR-Nozzle, 2.0 mm	1
	PR398-0002CP	L893X		PR-Nozzle, 2.0 mm CP	1
	PR398-552	L894	750.42.552	PR-Nozzle, 2.5 mm	1
	PR398-0004	L895	750.42.553	PR-Nozzle, 3.0 mm	1
2	PR421-111CP	L1239X	520.17.111	PR-Nozzle double, 1.5 mm CP	1
	PR421-114CP	L1240X	520.17.114	PR-Nozzle double, 2.0 mm CP	1
	PR421-560CP	L1241X	750.43.560	PR-Nozzle double, 2.5 mm CP	1
	PR421-561CP	L1242X	750.43.561	PR-Nozzle double, 3.0 mm CP	1
3	PR409-4513	L1213X	787.04.513	PR-Nozzle, 2.0 mm CP	1
	PR421-720 (not shown)	AL259	1058.36520.720	PR-Lens gasket	1

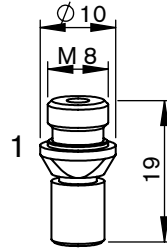

**Consumables**

	Centricut part number	Esse A part number	Reference number	Description	Pkg qty
	PR331-4102X	L3070	490.76.102	PR-Nozzle cylindrical, 0.3 mm brass (10 pk)	10
	PR331-3321BX	L3054	485.73.321	PR-Nozzle cylindrical, 1.5 mm brass (10 pk)*	10
	PR331-3321CX	L30419		PR-Nozzle cylindrical, 1.5 mm copper (10 pk)	10
	PR331-3322BX	L3055	485.73.322	PR-Nozzle cylindrical, 2.0 mm brass (10 pk)	10
	PR331-322CX	L30420		PR-Nozzle cylindrical, 2.0 mm copper (10 pk)	10
	PR331-3323BX	L30204	485.73.323	PR-Nozzle cylindrical, 2.5 mm brass (10 pk)	10
1	PR331-3323CX	L30421		PR-Nozzle cylindrical, 2.5 mm copper (10 pk)	10
	PR331-3324BX	L30205	485.73.324	PR-Nozzle cylindrical, 3.0 mm brass (10 pk)	10
	PR331-3324X	L30422		PR-Nozzle cylindrical, 3.0 mm copper (10 pk)	10
	PR331-0321CCPX	L30419X	485.73.421	PR-Nozzle, 1.5 mm CP (10 pk)*	10
	PR331-322CCPX	L30420X	485.73.422	PR-Nozzle, 2.0 mm CP (10 pk)*	10
	PR331-3323CCPX	L30421X	485.73.423	PR-Nozzle, 2.5 mm CP (10 pk)*	10
	PR331-3324CPX	L30422X	485.73.424	PR-Nozzle, 3.0 mm CP (10 pk)	10

\* Centricut parts available in single packs. To order single packs, remove the 'X' at the end of the part number (e.g. AM123-4567X would be AM123-4567).  
 For Esse A parts available in single packs. To order single packs, remove the '30' after the L in the part number (e.g. L301401X would be L401X).

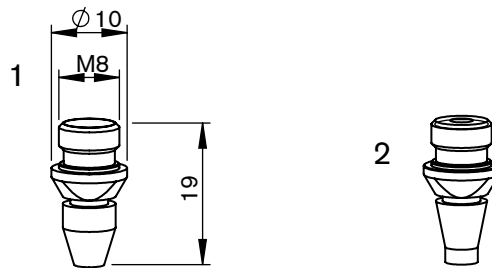

**Consumables**

	Centricut part number	Esse A part number	Reference number	Description	Pkg qty
1	PR393-0006X	L30634		PR-Nozzle, 2.0 mm (10 pk)	10
	PR393-0007X	L30635		PR-Nozzle, 2.5 mm (10 pk)*	10
	PR393-3455CPX	L301231X	485.73.455	PR-Nozzle con-cyl, 0.3 mm CP (10 pk)	10
	PR393-3451CPX	L301235X	485.73.451	PR-Nozzle con-cyl, 1.5 mm CP (10 pk)*	10
2	PR393-3452X	L301236	485.73.452	PR-Nozzle con-cyl, 2.0 mm (10 pk)*	10
	PR393-3452CPX	L301236X	485.73.452	PR-Nozzle con-cyl, 2.0 mm CP (10 pk)*	10
	PR393-3453CPX	L301237X	485.73.453	PR-Nozzle con-cyl, 2.5 mm CP (10 pk)*	10

\* Centricut parts available in single packs. To order single packs, remove the 'X' at the end of the part number (e.g. AM123-4567X would be AM123-4567).  
 For Esse A parts available in single packs. To order single packs, remove the '30' after the L in the part number (e.g. L301401X would be L401X).

Centricut is not affiliated with the named manufacturers. Reference to machines, parts, descriptions, and model numbers are for convenience in verifying compatibility only. All parts are made by or for Centricut and are not made by the referenced manufacturers (unless expressly indicated). Centricut is a registered trademark of Hypertherm, Inc. All other trademarks are the properties of their respective owners.



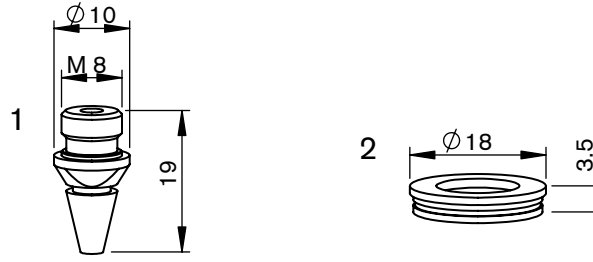

### Consumables

	Centricut part number	Esse A part number	Reference number	Description	Pkg qty
1	PR357-0001X	L3062	490.76.103	PR-Nozzle conical, 0.3 mm brass (10 pk)	10
	PR357-331BX	L30206	485.73.331	PR-Nozzle conical, 1.5 mm brass (10 pk)	10
	PR357-331CX	L30424	485.73.331	PR-Nozzle conical, 1.5 mm copper (10 pk)	10
	PR357-0004X	L30426		PR-Nozzle conical, 1.7 mm copper (10 pk)	10
	PR357-333BX	L3057	485.73.333	PR-Nozzle conical, 2.0 mm brass (10 pk)	10
	PR357-333CX	L30425		PR-Nozzle conical, 2.0 mm copper (10 pk)*	10
	PR357-0005X	L30449	485.73.333	PR-Nozzle conical, 2.5 mm brass (10 pk)	10
	PR357-0006X	L30427		PR-Nozzle conical, 2.5 mm copper (10 pk)	10
	PR357-0007X	L30630	485.73.43	PR-Nozzle conical, 3.0 mm copper (10 pk)	10
	PR357-331CCPX	L30424X	485.73.431	PR-Nozzle, 1.5 mm CP (10 pk)*	10
	PR357-322CCPX	L30425X	485.73.433	PR-Nozzle, 2.0 mm CP (10 pk)	10
	PR357-0006CPX	L30427X		PR-Nozzle, 2.5 mm CP (10 pk)	10
	PR357-0007CPX	L30630X	485.73.43X	PR-Nozzle, 3.0 mm CP (10 pk)	10
2	PR395-0002	AL163		PR-Insulating ring 7.5" Plastic	1
	PR395-0003	AL571	520.17.120	PR-Protection ring 11MM	1
	PR395-0001 (not shown)	AL136	480.73.107	PR-Insulating ring 5" Plastic	1

\* Centricut parts available in single packs. To order single packs, remove the 'X' at the end of the part number (e.g. AM123-4567X would be AM123-4567).  
For Esse A parts available in single packs. To order single packs, remove the '30' after the L in the part number (e.g. L301401X would be L401X).

### Consumables

	Centricut part number	Esse A part number	Reference number	Description	Pkg qty
	PR361-3151 <b>NEW</b> (not shown)	AL628	820.63.150	PR-Sensor cable, 150 mm (6") High profile	1
	PR361-3160 (not shown)	AL560	555.63.150	PR-Sensor cable, 210 mm (8 17/64")	1

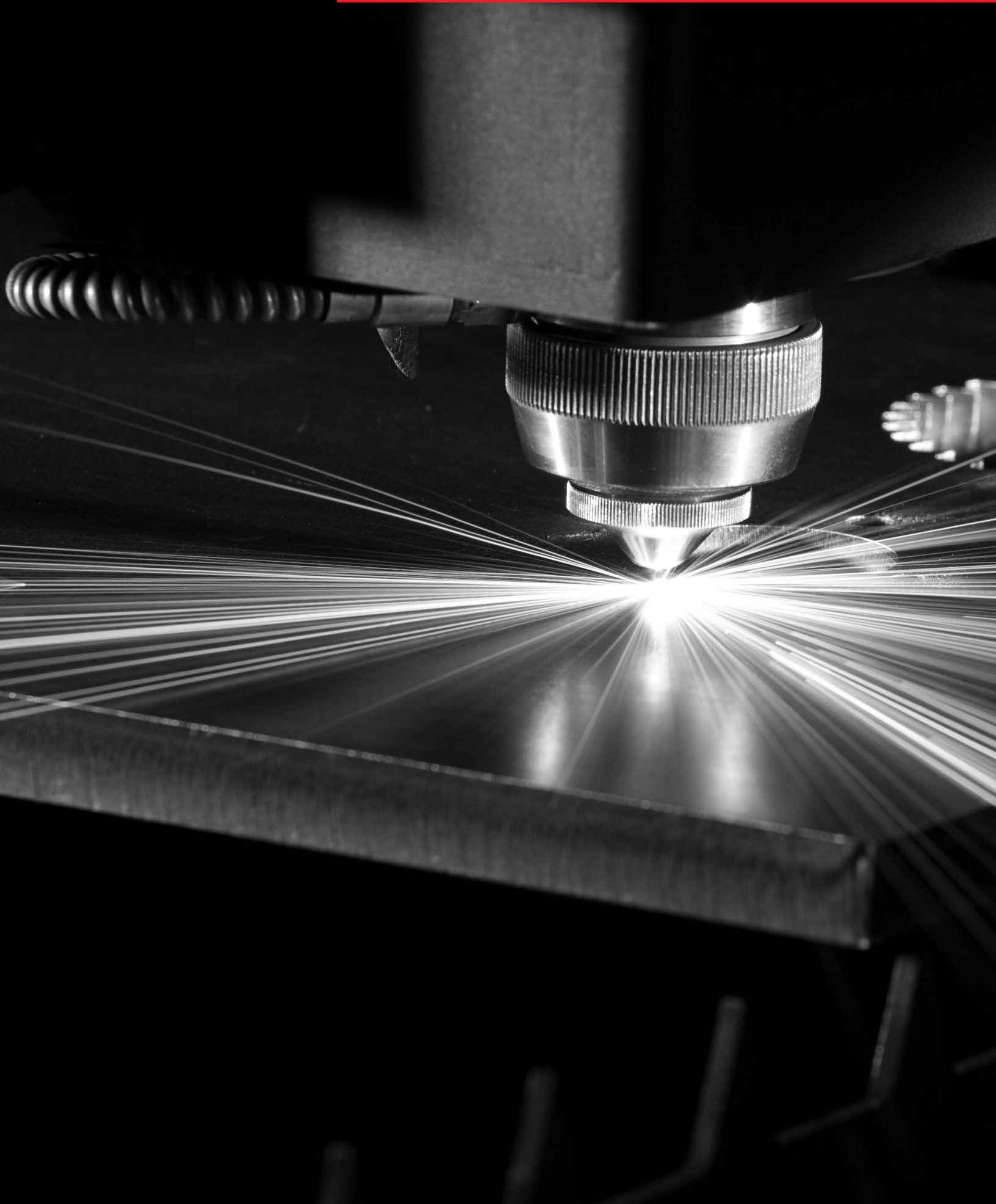

# Sensor cones



## Centricut sensor cones provide substantial cost savings without sacrificing performance or quality

- Available for Amada, Mazak, Mitsubishi and Precitec
- Delivers the same OEM performance at a lower cost
- Unmatched performance and reliability
- Engineered and manufactured to Hypertherm's precise quality standards
- Backed by our one-year warranty and 100% satisfaction guarantee

Centricut part number	Esse A part number	OEM	Reference number	Description
AM343-0091	AL600	Amada	71360091	AM-Sensor cone, HS95 mini
AM343-1621*	AL601	Amada	71341621	AM-Sensor cone, HS95
AM343-9107	AL603	Amada	ECO cone	AM-Sensor cone, ECO
AM343-1690	AL602	Amada	71341690	AM-Sensor cone, HS98
AM343-L3015C	AL550	Amada	71374509	PT-Sensor cone, LC3015
AM343-2443		Amada	7172443, 771041	AM-Sensor cone, HPL Blue
AM343-4233B*	AL551	Amada	71564233	AM-Sensor cone, HPL Black
AM343-4233G*	AL552	Amada	71564233	AM-Sensor cone, HPL Gold
PT347-3323	AL611	Mazak	HNP	PT-Sensor cone, HNP
MZ335-HNPS*	AL605	Mazak	HNPS	MZ-Sensor cone, HNP short version
PT347-0007		Mazak	56743300500	PT-Sensor cone, HNZ (Mazak)
PT347-0011*	AL607	Mitsubishi	P0354-110-00002	PT-Sensor cone, HNZ (Mitsubishi)
MB334-W429A	AL604	Mitsubishi	P0461-270-00001	MB-Sensor cone, W429A
PT347-0238*	AL608	Precitec	BQ930D238G01	PT-Sensor cone, HNZ SMA
PT347-8001	AL612	Precitec	P0361-203-00001	PT-Sensor cone, 2.5Z/J
PT347-0522*	AL609	Precitec	P0599-520-00002	PT-Sensor cone, LRC
PT347-1145	AL610	Precitec	P0380-140-0002, P0380-130-00001, 281145	PT-Sensor cone, DZ

\*Sensor cone repair service is available for most sensor cones in North America and select international regions. For more information contact [Ctlaser@Hypertherm.com](mailto:Ctlaser@Hypertherm.com).

Centricut is not affiliated with the named manufacturers. Reference to machines, parts, descriptions, and model numbers are for convenience in verifying compatibility only. All parts are made by or for Centricut and are not made by the referenced manufacturers (unless expressly indicated). Centricut is a registered trademark of Hypertherm, Inc. All other trademarks are the properties of their respective owners.



# Armored sensor cables

## Centricut armored sensor cables outlast standard OEM cables

- Available for all major brands
- Robust design with extreme temperature rating (900–1200°)
- Longer life reduces downtime and production loss
- Spatter resistant stainless steel armoring
- Reinforced collars and high-quality connector

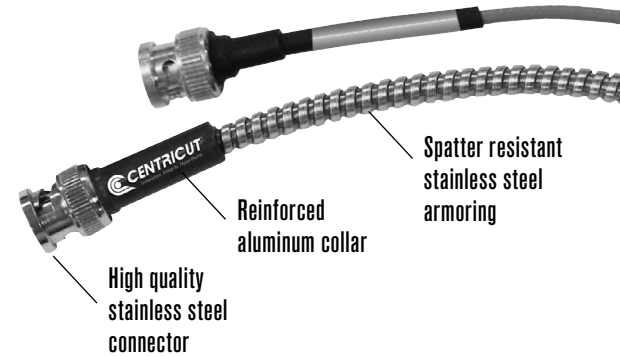

### Armored sensor cables

Centricut part number	Esse A part number	OEM	Reference number	Description
AM308-8965	AL260	Amada	71398965	AM-Sensor cable, 305 mm (12")
AM308-8965A	AL613	Amada	71398965	AM-Sensor cable, 305 mm (12") armored
AM313-1901	AL200	Amada	71341630	AM-Sensor cable HS-5, 305 mm (12")
AM313-1901A		Amada	71341630	AM-Sensor cable HS-5, 305 mm (12") armored
AM313-8292	AL615	Amada	71398292	AM-Sensor cable dual shield, 7 m (275.6")
AM313-9851A		Amada	71369851	AM-Sensor cable, 203 mm (8") armored
CN306-0654A	AL616	Cincinnati	909654, 922686	CN-Sensor cable, 114 mm (4.5") armored
CN306-0951A	AL617	Cincinnati	842951	CN-Sensor cable, 140 mm (5.5") armored
CN306-2951	AL618	Cincinnati	842951, PLTTW0015	CN-Sensor cable, 140 mm (5.5")
CN306-9654	AL619	Cincinnati	909654, 922686, PLTTW0002	CN-Sensor cable, 114 mm (4.5")
MZ335-0111A	AL620	Mazak	4674330111	MZ-Sensor cable, 280 mm (11") armored
MZ335-0181A	AL621	Mazak	46743300181	MZ-Sensor cable, 317.5 mm (12.5") armored
MZ335-1330A	AL622	Mazak	46683301330	MZ-Sensor cable, 305 mm (12") armored
MZ335-1980A	AL643	Mazak	46683301980	MZ-Sensor cable, 280 mm (11") armored
MZ335-5320	AL105	Mazak	6143355320	MZ-Sensor cable, 61.5 mm (2.4") armored
MZ335-630A	AL623	Mazak	00BSBA630MNC	MZ-Sensor cable, 630 mm (25") armored
MZ335-8290	AL368	Mazak	46143308290	MZ-Sensor cable, 75 mm (3")
NT426-1682	AL624	NTC	4R029911-001, J482D	NT-Sensor cable, 216 mm (8.5")
NT426-4991	AL625	NTC	3-0104991	NT-Sensor cable 0-0BNC/MCX, 482 mm (19")
NT426-7492	AL626	NTC	3-0117492	NT-Sensor cable 90BNC/90BNC, 482 mm (19")
NT426-8677	AL627	NTC	4R028677-001	NT-Sensor cable, 508 mm (20") armored
PR361-3150	AL628	Prima	820.63.150	PR-Sensor cable, 150 mm (5.9")
PR361-3151	AL629	Prima	820.63.150	PR-Sensor cable, 150 mm (6") high profile
PR361-3160	AL560	Prima	555.63.150	PR-Sensor cable, 210 mm (8 17/64")
PT347-0101A	AL633	Precitec	P0360-100-00500	PT-Sensor cable, 500 mm (20") armored
PT347-0181	AL358	Precitec	46743300181	PT-Sensor cable, 305 mm (12") armored
PT347-0300A	AL635	Precitec	P0492-014-00300	PT-Sensor cable KE, 300 mm (11.8") armored
PT347-0450		Precitec	P0497-002-00450	PT-Sensor cable, 450 mm (17.7")
PT347-KS13	AL639	Precitec/ Gunkyo	00BMTKA-A-HS500mm	PT-Sensor cable, 390 mm (15.5") armored
PT347-1250	AL637	Precitec	D5001-040-00250	PT-Sensor cable, 250 mm (9.8") armored
TR301-0930	AL640	Trumpf	280930	TR-Sensor cable, 152 mm (6") armored
TR301-7833	AL641	Trumpf	227833	TR-Sensor cable, 432 mm (17")
TR301-9983	AL642	Trumpf	359983, 342474	TR-Sensor cable, 190 mm (7.5") armored

Centricut is not affiliated with the named manufacturers. Reference to machines, parts, descriptions, and model numbers are for convenience in verifying compatibility only. All parts are made by or for Centricut and are not made by the referenced manufacturers (unless expressly indicated). Centricut is a registered trademark of Hypertherm, Inc. All other trademarks are the properties of their respective owners.

# Lens cleaning tips



## Centricut supplies suitable for all OEM CO<sub>2</sub> and fiber laser lenses

- Lens maintenance base is designed to secure a wide range of optics sizes for the cleaning process
- Centricut optical cleaning fluid is a safe, economical alternative to traditional high-purity and reagent-grade solvents
- Cleaning materials suited for all lens cleaning needs; lens paper, polyester swabs and polyester wipes

### Lens paper

Recommended for the routine maintenance cleaning of flat lenses.

### Polyester swabs

Recommended for cleaning curved lenses and where a more aggressive cleaning is required (interchangeable with polyester wipes).

### Polyester wipes

Recommended for cleaning CO<sub>2</sub> and fiber lenses and windows (interchangeable with polyester swabs and lens paper).

Product description	Part number	Quantity per order
Optical cleaning fluid (3 oz.)	TR300-1112	1
Lens cleaning swab	TR300-0699	25
Lens cleaning paper, Tiffen	TR300-6452	50
Polyester wipes 4" x 4"	TR300-7991	100
Base, lens maintenance	TR300-271	1

## Lens paper

Recommended for the routine maintenance cleaning of flat lenses.

### You will need:

- Lens maintenance base (lens holder)
- Optical cleaning fluid
- Air bulb
- Lint-free lens paper
- Latex or rubber gloves

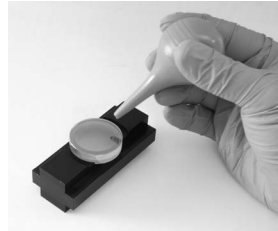

### To get started

Using rubber gloves, place the lens in the lens holder and remove all loose contaminants with an air bulb. When contaminants are no longer visible, begin the cleaning process.

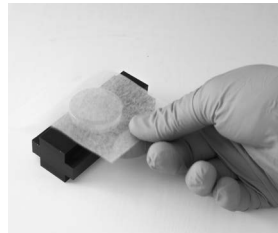

### Step 1

Place lens paper over the optic, covering it completely.



### Step 2

Apply a couple drops of lens cleaning fluid to the lens paper (far side of the lens).

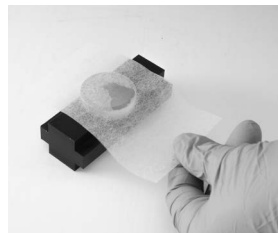

### Step 3

Slowly pull the lens paper across the lens so the cleaning fluid comes in contact with the entire lens surface. Finish pulling the paper across so all of the fluid has dried from the lens.

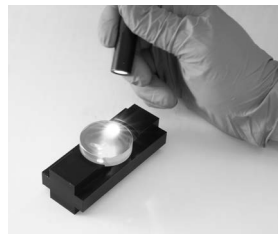

### Step 4

Inspect the surface of the lens for dust and cleaning residue using a flashlight. Examine the lens from different angles. Repeat the process on the other side of the lens.

### Final step:

Place the cleaned lens in the machine quickly to avoid contamination from airborne particles. If spots, pits, or scratches are still noticeable, the lens may need to be replaced.

Centricut is not affiliated with the named manufacturers. Reference to machines, parts, descriptions, and model numbers are for convenience in verifying compatibility only. All parts are made by or for Centricut and are not made by the referenced manufacturers (unless expressly indicated). Centricut is a registered trademark of Hypertherm, Inc. All other trademarks are the properties of their respective owners.

## Polyester swabs

Recommended for cleaning curved lenses and where more aggressive cleaning is required. Interchangeable with polyester wipes.

### You will need:

- Lens maintenance base (lens holder)
- Optical cleaning fluid
- Air bulb
- Polyester swabs
- Latex or rubber gloves

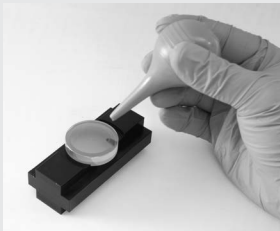

### To get started

Using rubber gloves, place the lens in the lens holder and remove all loose contaminants with an air bulb. When contaminants are no longer visible, begin the cleaning process.



### Step 1

Place a few drops of the optical cleaning fluid onto the swab.

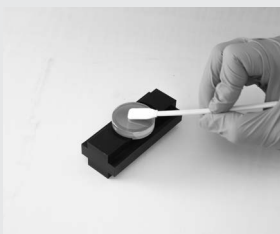

### Step 2

Move the larger dirt particles and then finer contaminants to the edge of the lens using the swab. Do not rest the swab on the lens or on the work table. Do not reuse swabs.

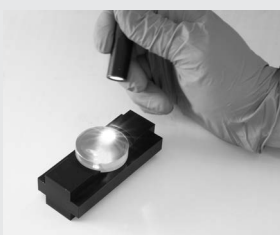

### Step 3

Inspect the surface of the lens for dust and cleaning residue using a flashlight. Examine the lens from different angles. Repeat the process on the other side of the lens.

### Final step:

Place the cleaned lens in the machine quickly to avoid contamination from airborne particles. If spots, pits, or scratches are still noticeable, the lens may need to be replaced.

## Polyester wipes

Recommended for cleaning CO<sub>2</sub> and fiber lenses and windows. Interchangeable with polyester swabs and lens paper.

### You will need:

- Lens maintenance base (lens holder)
- Optical cleaning fluid
- Air bulb
- Polyester wipes
- Latex or rubber gloves

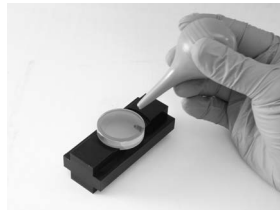

### To get started

Using rubber gloves, place the lens in the lens holder and remove all loose contaminants with an air bulb. When contaminants are no longer visible, begin the cleaning process.



### Step 1

Place a few drops of the optical cleaning fluid onto the polyester wipe.



### Step 2

Place the wipe with the wet side down on the lens and slide it across the lens, applying light pressure to the top of the wipe. Avoid contamination to the wipe and do not reuse wipes.

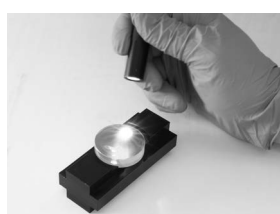

### Step 3

Inspect the surface of the lens for dust and cleaning residue using a flashlight. Examine the lens from different angles. Repeat the process on the other side of the lens.

### Final step:

Place the cleaned lens in the machine quickly to avoid contamination from airborne particles. If spots, pits, or scratches are still noticeable, the lens may need to be replaced.



# Steps to help optimize cut quality.

Striation marks, angularity and dross tell the story.

Optimizing CO<sub>2</sub> and fiber lasers to achieve maximum cut quality is a very important step in the overall cutting process. The critical points that produce good cuts are the width of the kerf (the material that is lost during the cut), oxidation and roughness of the cut surface, the geometry of the cut parts and the allowable tolerances. Some factors to be considered are the cut speed or 'feed rate', beam focus, gas pressure, standoff and nozzle size/type.

## Factory cut chart settings

The following samples show 12 mm, 6 mm and 3.2 mm (1/2", 1/4" and 10 ga.) mild steel, cut with O<sub>2</sub> on a 2 kW fiber laser with one variable changed to show how cut quality is affected. The adjustments will be similar for all CO<sub>2</sub> and fiber laser, cutting mild steel with O<sub>2</sub>.

## Is the kerf too narrow?

When the kerf is too narrow the cut will have a very smooth edge on the top, a lack of oxidation on the bottom and/or heavy dross.

### Probable causes:

- Focus is too low
- Feed rate is too fast
- Gas pressure is too low
- Nozzle size is too small
- Standoff is too low

### Follow these steps to optimize cut quality:

1. Use the closest known settings for the material being cut.
2. Use a test part that has both interior and exterior features.
3. Verify that the lens and/or window is clean and in good condition.
4. Verify that the nozzle is centered properly and is in good condition.
5. Adjust the focus up and down until the cut quality starts to get bad and then set to the middle of that range.
6. Adjust the gas pressure up and down until the cut starts to get bad and then set to the middle of that range.
7. Adjust the feed rate up by 5% increments. When the cut starts to get bad, set the feed rate 10% slower.

## Strike a balance between heat levels and gas flow

Cutting mild steel with a laser is a balance of how much material is heated by the laser beam and how much assist gas flows through the cut.

- Heating up too small of an area, or not having enough assist gas flow through the cut will result with the kerf (width of the cut) being too narrow.
- Heating up too large of an area or having too much assist gas flow through the cut will result in the kerf being too wide.

## Is the kerf too wide?

When the kerf is too wide the cut will have a rougher edge, more self burning in the corners of the part, more angularity on the cut edge and occasionally, dross.

### Probable causes:

- Focus is too high
- Feed rate is too slow
- Gas pressure is too high
- Nozzle size is too big
- Standoff is too high
- Incorrect nozzle type

## 3.2 mm (10 ga.) mild steel cut resulting in too narrow kerf

### Factory cut chart settings

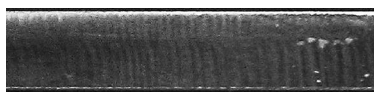

### Focus is too low

The kerf is too narrow and doesn't allow enough O<sub>2</sub> into the cut to remove all the molten material.

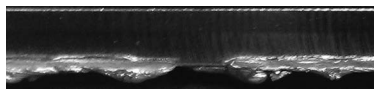

### Feed rate is too fast

The cut striations are trailing the direction of cutting and there is not enough time to remove all the molten material.

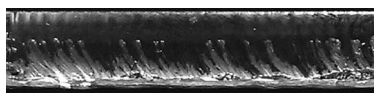

### Gas pressure is too low

There is not enough O<sub>2</sub> to remove all the molten material.

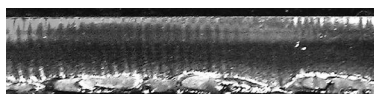

### Stand off is too low

The focus spot is in the wrong location, causing the rough edge.

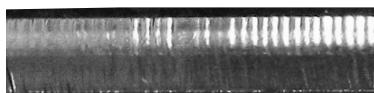

## 3.2 mm (10 ga.) mild steel cut resulting in too wide kerf

### Factory cut chart settings



### Focus is too high

The laser is melting more material than can be removed from the cut.

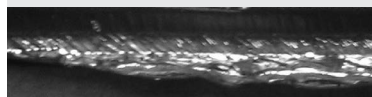

### Feed rate is too slow

The cut surface is too rough and productivity is decreased.

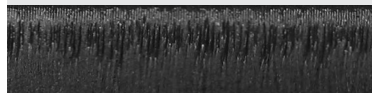

### Gas pressure is too high

Too much O<sub>2</sub> results in overheating of the cut and causes intermittent gouges.



### Stand off is too high

The laser is melting more material than can be removed from the cut.

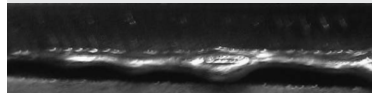

### Nozzle size is too big

Too much O<sub>2</sub> results in overheating of the cut and causes intermittent gouges.

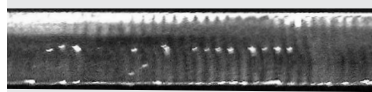

Cut direction

Cut direction

\*Above samples have been cut with O<sub>2</sub> on 2 kW fiber laser. Results will be similar for CO<sub>2</sub> laser cutting mild steel with O<sub>2</sub>.

## 6 mm (1/4") mild steel cut resulting in too narrow kerf

### Factory cut chart settings

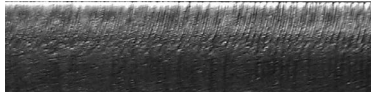

### Focus is too low

The kerf is too narrow and doesn't allow enough O<sub>2</sub> into the cut to remove all the molten material.

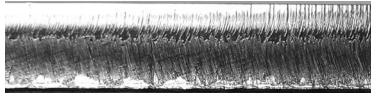

### Feed rate is too fast

The cut striations are trailing the direction of cutting and there is not enough time to remove all the molten material.

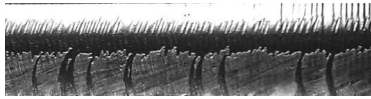

### Gas pressure is too low

There is not enough O<sub>2</sub> to remove all the molten material.

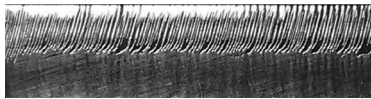

### Stand off is too low

The focus spot is in the wrong location, causing the rough edge.

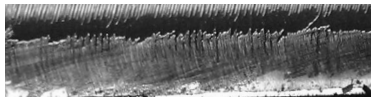

### Nozzle size is too small

There is not enough O<sub>2</sub> to cut uniformly.

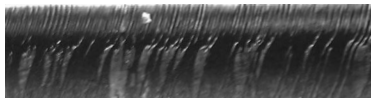

## 6 mm (1/4") mild steel cut resulting in too wide kerf

### Factory cut chart settings

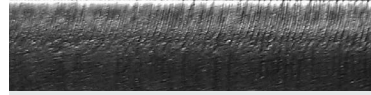

### Focus is too high

The wider focus spot is letting too much O<sub>2</sub> into the cut and burning the material.

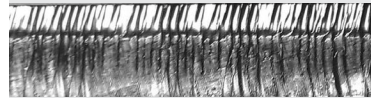

### Feed rate is too slow

The cut surface is too rough and productivity is decreased.

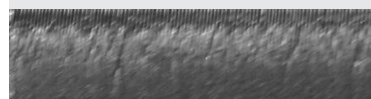

### Gas pressure is too high

Too much O<sub>2</sub> is entering the cut, causing a rougher edge and inconsistent cutting.



### Stand off is too high

Too much O<sub>2</sub> is entering the cut, causing a rougher edge and inconsistent cutting.

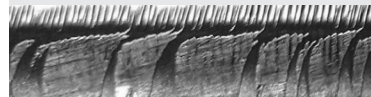

### Nozzle size is too big

Too much O<sub>2</sub> results in overheating of the cut and causes intermittent gouges.



### Nozzle type is incorrect

The shape of the gas flow is incorrect, causing a rougher edge.

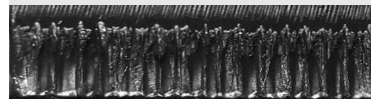

Cut direction

Cut direction

\*Above samples have been cut with O<sub>2</sub> on 2 kW fiber laser. Results will be similar for CO<sub>2</sub> laser cutting mild steel with O<sub>2</sub>.

Centricut is not affiliated with the named manufacturers. Reference to machines, parts, descriptions, and model numbers are for convenience in verifying compatibility only. All parts are made by or for Centricut and are not made by the referenced manufacturers (unless expressly indicated). Centricut is a registered trademark of Hypertherm, Inc. All other trademarks are the properties of their respective owners.

# 12 mm (1/2") mild steel cut resulting in too narrow kerf

## Factory cut chart settings

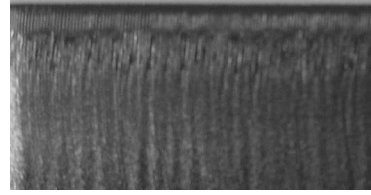
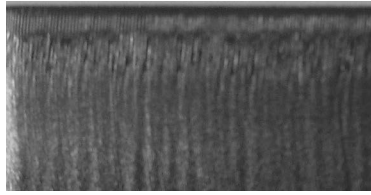

## Factory cut chart settings

### Focus is too low

The kerf is too narrow and doesn't allow enough O<sub>2</sub> into the cut to remove all the molten material.

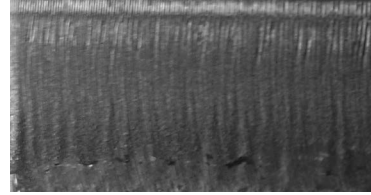
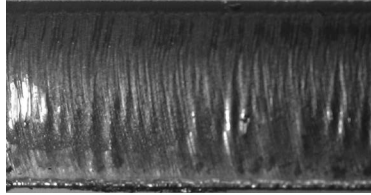

### Stand off is too low

The kerf is too narrow to allow enough O<sub>2</sub> into the cut. The oxidation is not covering the entire surface and cutting will be inconsistent.

### Feed rate is too fast

The machine is moving too fast to allow enough O<sub>2</sub> into the cut for consistent cutting.

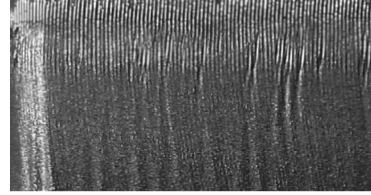
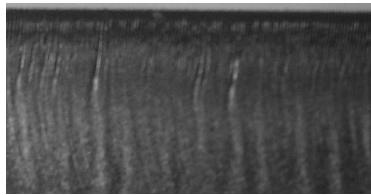

### Nozzle size is too small

There is not enough O<sub>2</sub> to cut uniformly.

### Gas pressure is too low

The pressure is too low to allow enough O<sub>2</sub> into the cut. The oxidation is not covering the entire surface and cutting will be inconsistent.

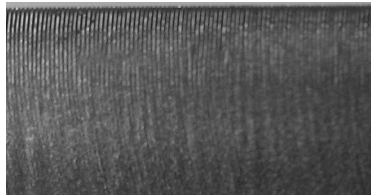

Cut direction

Cut direction

\*Above samples have been cut with O<sub>2</sub> on 2 kW fiber laser. Results will be similar for CO<sub>2</sub> laser cutting mild steel with O<sub>2</sub>.

Centricut is not affiliated with the named manufacturers. Reference to machines, parts, descriptions, and model numbers are for convenience in verifying compatibility only. All parts are made by or for Centricut and are not made by the referenced manufacturers (unless expressly indicated). Centricut is a registered trademark of Hypertherm, Inc. All other trademarks are the properties of their respective owners.

# 12 mm (1/2") mild steel cut resulting in too wide kerf

**Factory cut chart settings**

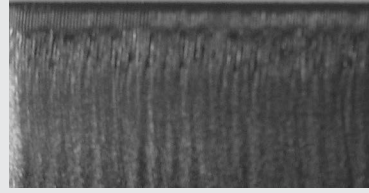
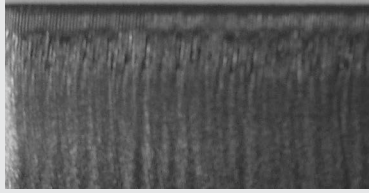

**Factory cut chart settings**

**Focus is too high**

Too much O<sub>2</sub> is entering the cut causing intermittent over burning.

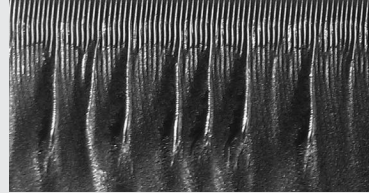
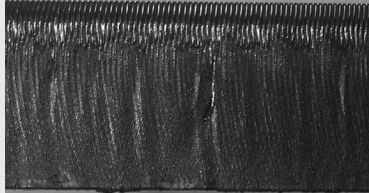

**Stand off is too high**

Too much O<sub>2</sub> is entering the cut resulting in intermittent over burning.

**Feed rate is too slow**

The machine is moving too slow resulting in the over burning of the bottom half of the cut. The slower feed rate also reduces productivity.

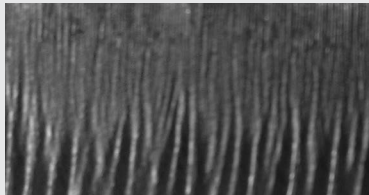

**Incorrect nozzle type**

The gas flow shape is not correct resulting in inconsistent cutting.

**Gas pressure is too high**

Too much O<sub>2</sub> is entering the cut resulting in intermittent over burning.

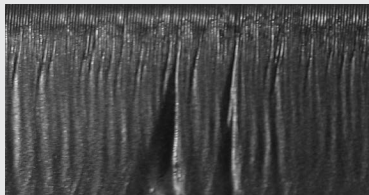

\*Above samples have been cut with O<sub>2</sub> on 2 kW fiber laser. Results will be similar for CO<sub>2</sub> laser cutting mild steel with O<sub>2</sub>.

Centricut is not affiliated with the named manufacturers. Reference to machines, parts, descriptions, and model numbers are for convenience in verifying compatibility only. All parts are made by or for Centricut and are not made by the referenced manufacturers (unless expressly indicated). Centricut is a registered trademark of Hypertherm, Inc. All other trademarks are the properties of their respective owners.



## Technical support and customer service

Our technical service team can answer questions about any laser cutting system. Whether it's a question about a part, a system or for guidance on how to optimize laser cutting performance, our experts can help.

- OEM trained technicians with over 40 years experience
- Free application support for all laser OEMs
- We stand behind our products with industry-leading technical expertise



Contact a laser expert at [ctlaser@hypertherm.com](mailto:ctlaser@hypertherm.com)

# SHAPING POSSIBILITY<sup>®</sup>

PLASMA | LASER | WATERJET | AUTOMATION | SOFTWARE | CONSUMABLES

For more information on Centricut laser products,  
visit [www.hypertherm.com/laserconsumables](http://www.hypertherm.com/laserconsumables)  
or email [ctlaser@hypertherm.com](mailto:ctlaser@hypertherm.com)

Hypertherm, Centricut, SilverLine and CoolFlow are trademarks of Hypertherm, Inc., and may be registered in the United States and/or other countries. All other trademarks are the property of their respective owners.

Please visit [www.hypertherm.com/patents](http://www.hypertherm.com/patents) for more details about Hypertherm Associates patent numbers and types.

© 3/2023 Hypertherm, Inc. Revision 11



As 100% Associate owners, we are all focused on delivering a superior customer experience.  
[www.hyperthermassociates.com/ownership](http://www.hyperthermassociates.com/ownership)

Environmental stewardship is one of Hypertherm Associates' core values. [www.hyperthermassociates.com/environment](http://www.hyperthermassociates.com/environment)

100% Associate-owned

